

- Mounting Alternatives -

Items in RED are standard CSW extrusions.

Options can be used in conjunction with one another.

Not all options shown will work in all applications.

Modifications may be needed based upon your exact application.

Most alternatives can be used in any orientation (ie: top, sides, etc)

This is not a finite list - endless possibilities and custom methods exist.

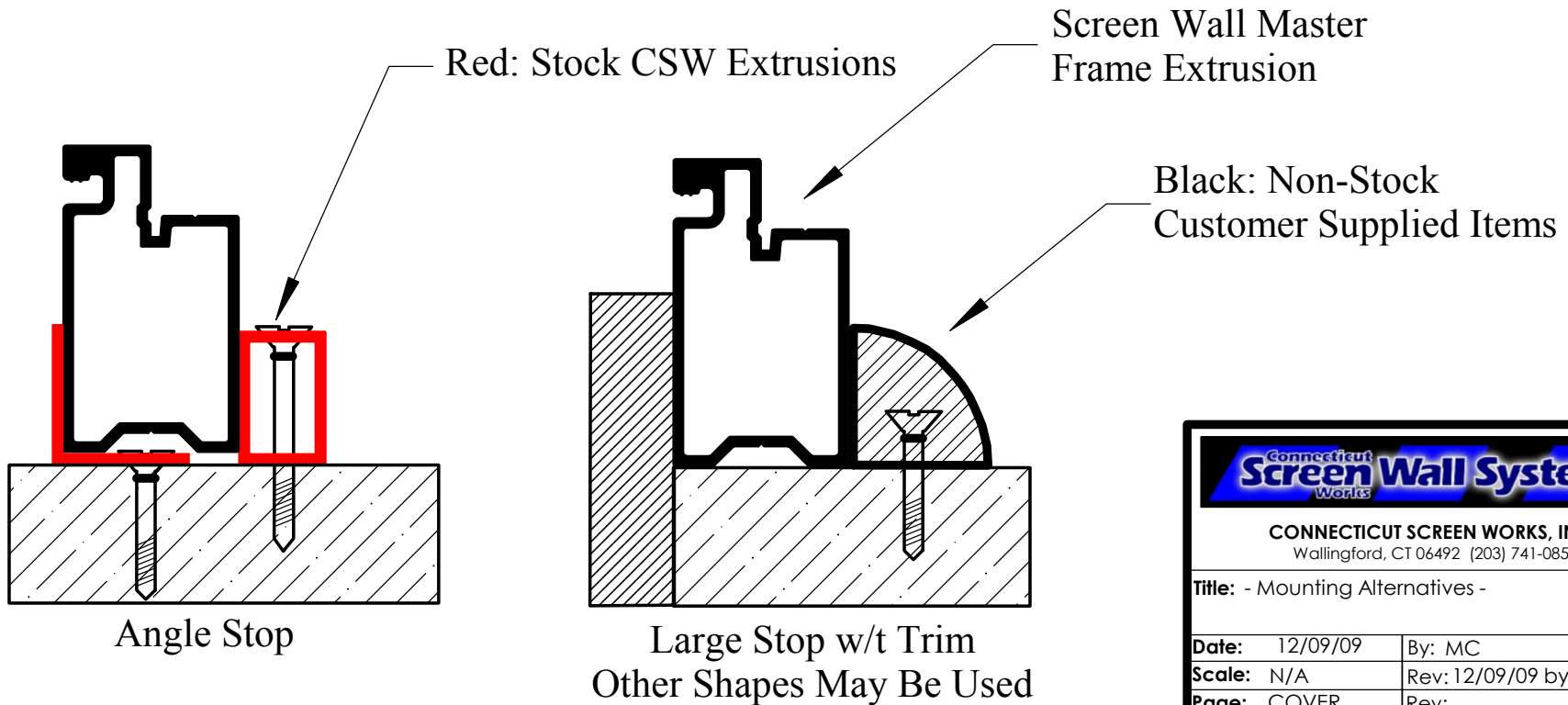

	
<b>CONNECTICUT SCREEN WORKS, INC</b> Wallingford, CT 06492 (203) 741-0859	
<b>Title:</b> - Mounting Alternatives -	
<b>Date:</b> 12/09/09	<b>By:</b> MC
<b>Scale:</b> N/A	<b>Rev:</b> 12/09/09 by MC
<b>Page:</b> COVER	<b>Rev:</b>
<b>Alloy:</b>	<b>Rev:</b>
<b>Temper:</b>	<b>Patent:</b>
<b>Length:</b>	System - Pending
<b>Die:</b>	
all contents copyright 2009 by CSW, Inc.	

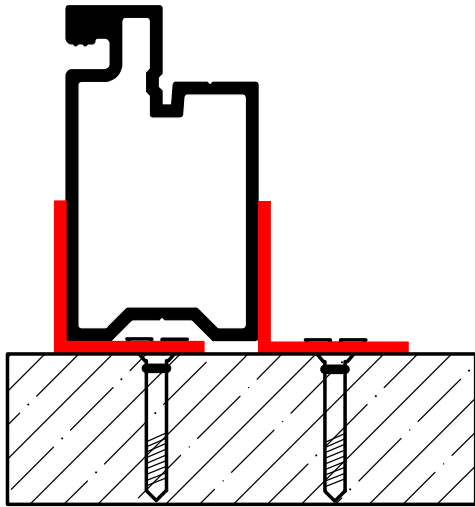

Double Angle

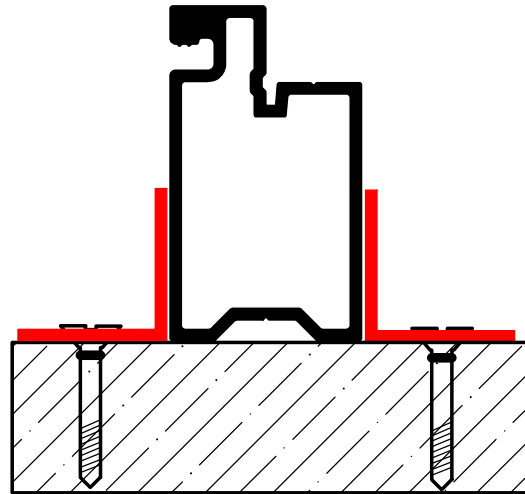

Double Angle

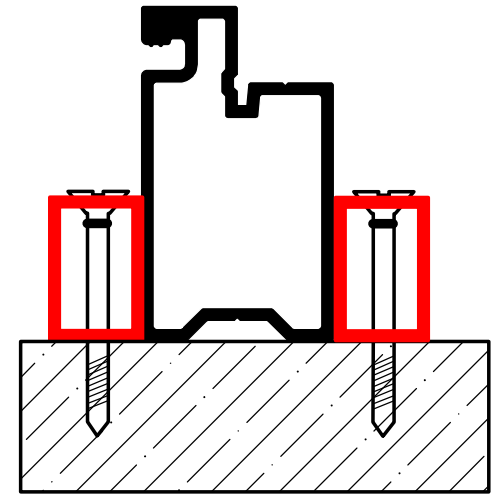

Double Stop

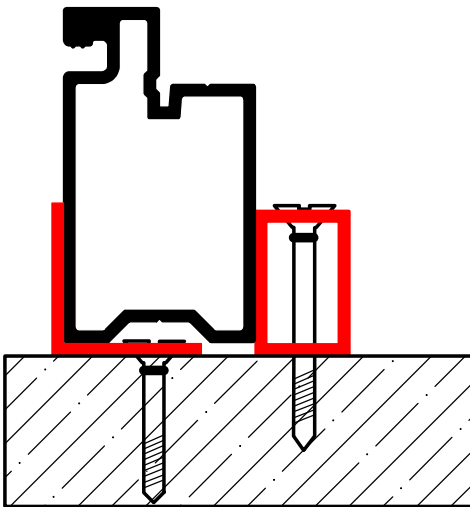

Angle Stop

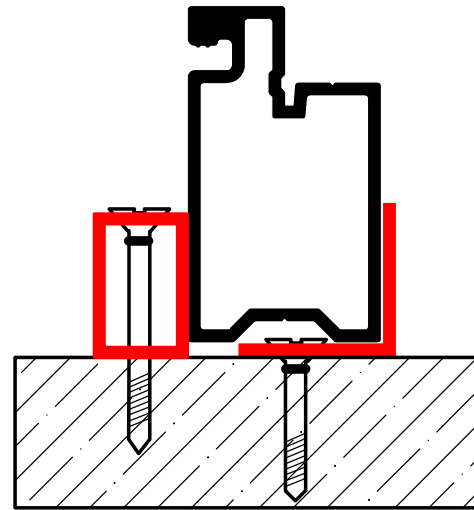

Reversed Angle Stop

	
<b>CONNECTICUT SCREEN WORKS, INC</b> Wallingford, CT 06492 (203) 741-0859	
<b>Title:</b> - Mounting Alternatives -	
<b>Date:</b> 12/09/09	<b>By:</b> MC
<b>Scale:</b> N/A	<b>Rev:</b> 12/09/09 by MC
<b>Page:</b> 1 OF 2	<b>Rev:</b>
<b>Alloy:</b>	<b>Rev:</b>
<b>Temper:</b>	<b>Patent:</b>
<b>Length:</b>	System - Pending
<b>Die:</b>	
<small>all contents copyright 2009 by CSW, Inc.</small>	

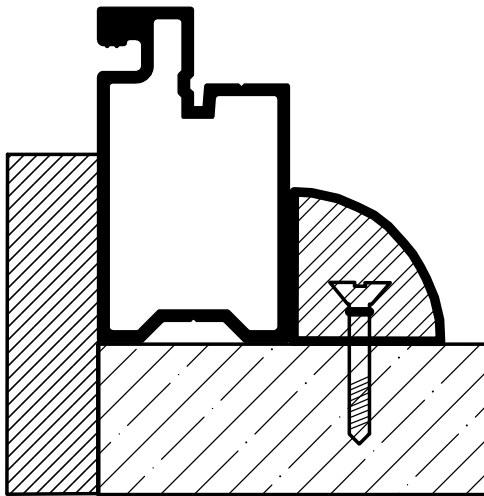

Large Stop w/t Trim  
Other Shapes May Be Used

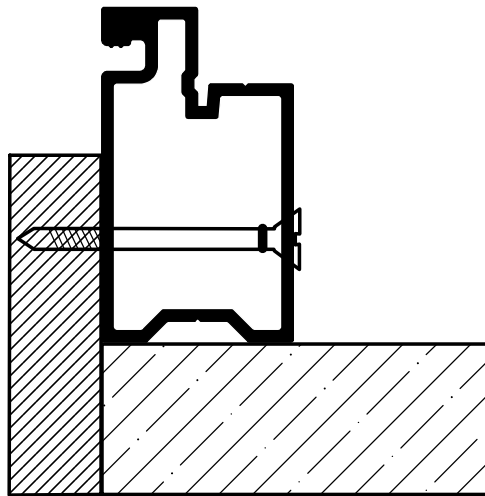

Large Stop  
Other Shapes May Be Used

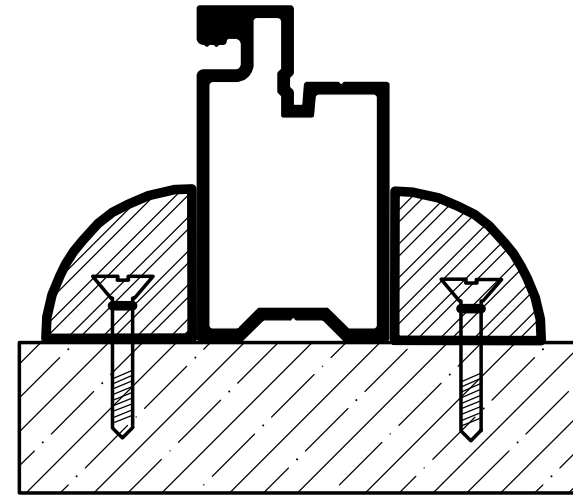

Small Stops  
Other Shapes May Be Used

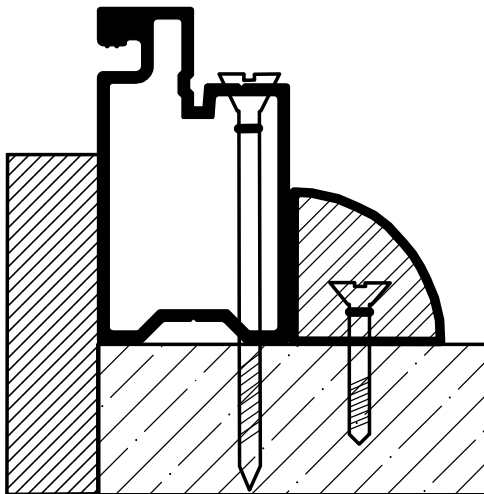

Large Stop w/t Trim  
(Side Screwed)  
Other Shapes May Be Used

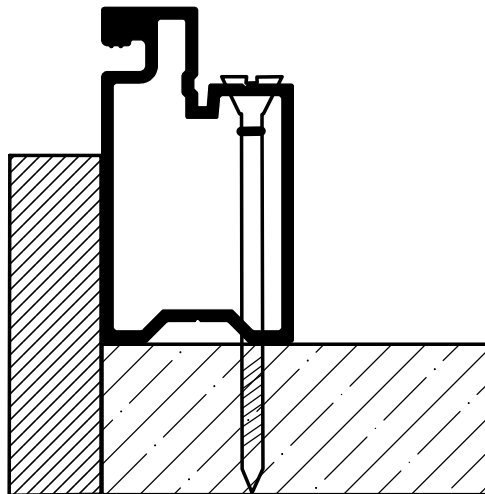

Large Stop  
(Side Screwed)

	
<b>CONNECTICUT SCREEN WORKS, INC</b> Wallingford, CT 06492 (203) 741-0859	
<b>Title:</b> - Mounting Alternatives -	
<b>Date:</b> 12/09/09	<b>By:</b> MC
<b>Scale:</b> N/A	<b>Rev:</b> 12/09/09 by MC
<b>Page:</b> 2 OF 5	<b>Rev:</b>
<b>Alloy:</b>	<b>Rev:</b>
<b>Temper:</b>	<b>Patent:</b>
<b>Length:</b>	System - Pending
<b>Die:</b>	
<small>all contents copyright 2009 by CSW, Inc.</small>	

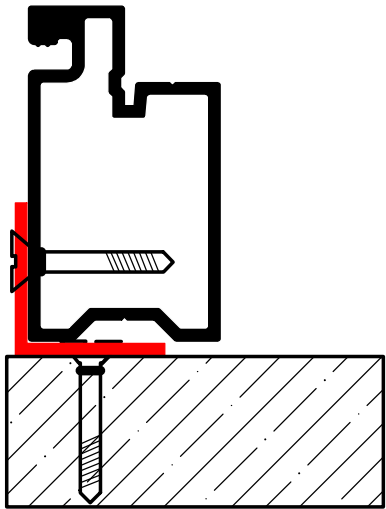

Angle Mount

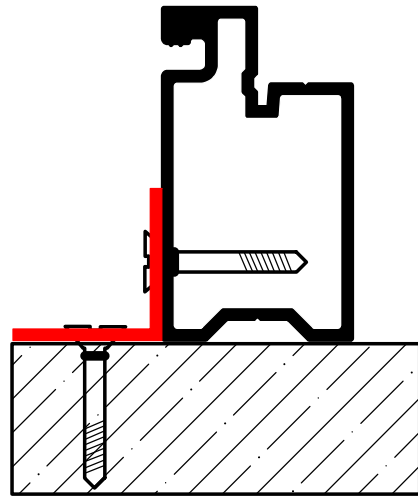

Angle Mount

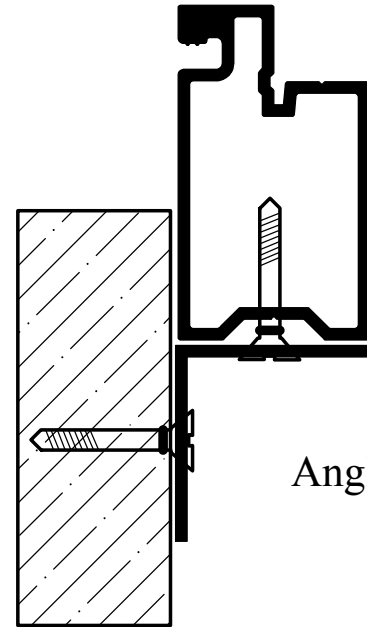

Angle Mount

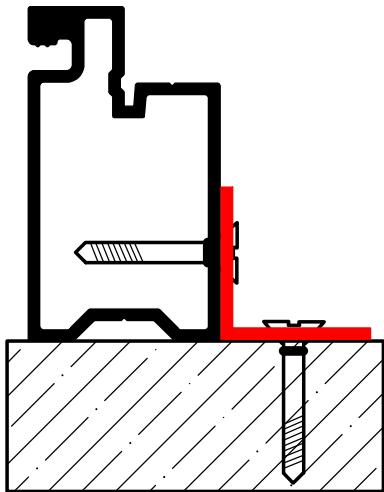

Angle Mount

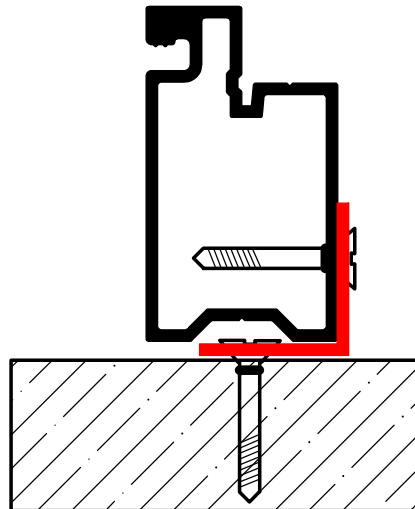

Angle Mount

	
<b>CONNECTICUT SCREEN WORKS, INC</b> Wallingford, CT 06492 (203) 741-0859	
<b>Title:</b> - Mounting Alternatives -	
<b>Date:</b> 12/09/09	<b>By:</b> MC
<b>Scale:</b> N/A	<b>Rev:</b> 12/09/09 by MC
<b>Page:</b> 3 OF 5	<b>Rev:</b>
<b>Alloy:</b>	<b>Rev:</b>
<b>Temper:</b>	<b>Patent:</b>
<b>Length:</b>	System - Pending
<b>Die:</b>	
<small>all contents copyright 2009 by CSW, Inc.</small>	

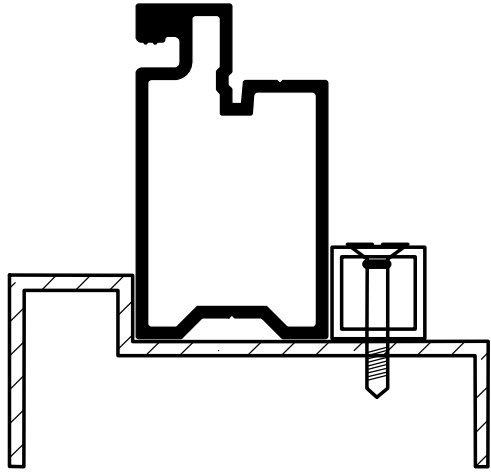

Store Front Extrusion

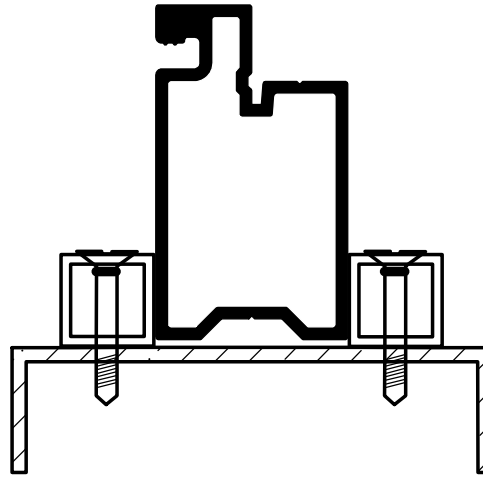

Store Front Extrusion

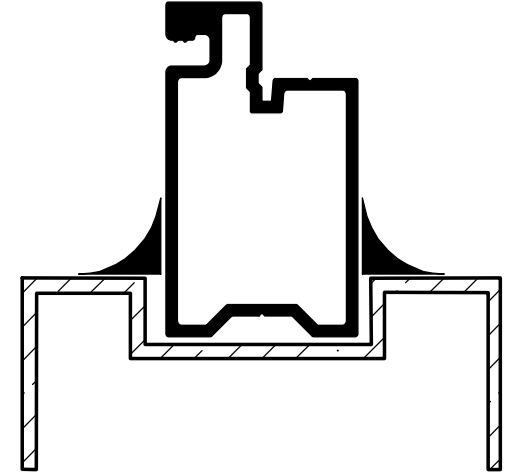

Store Front Extrusion

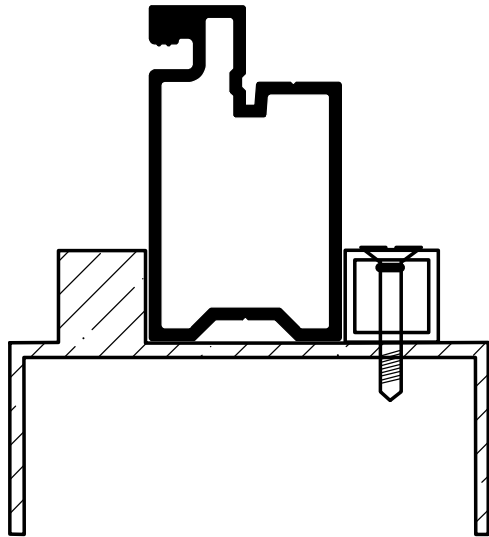

Store Front Extrusion

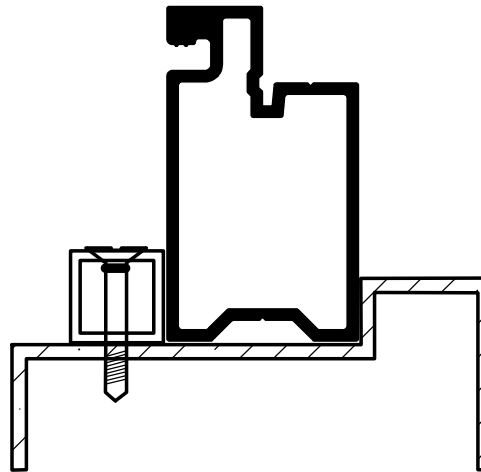

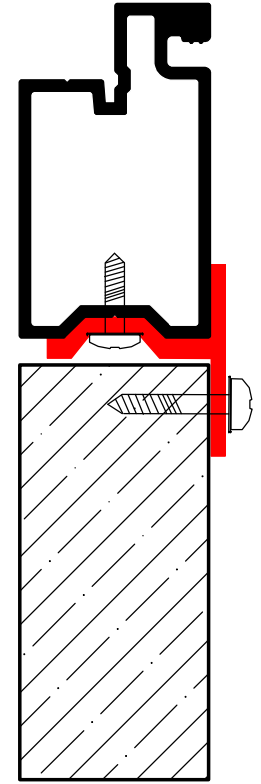
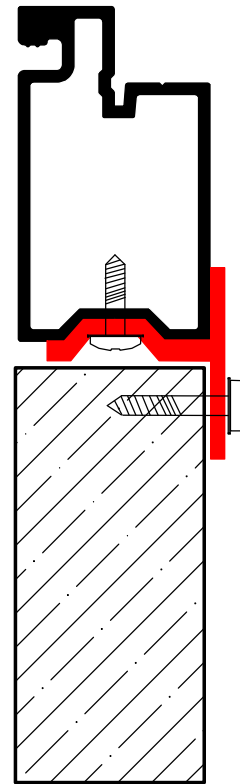
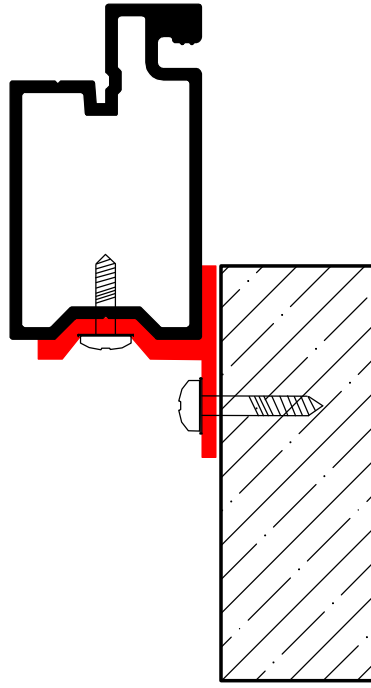
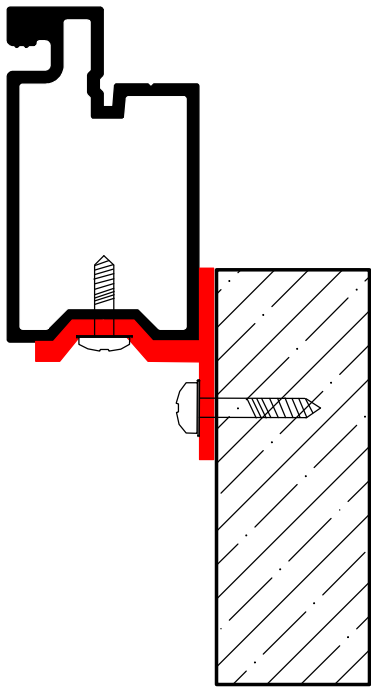

Store Front Extrusion

	
<b>CONNECTICUT SCREEN WORKS, INC</b> Wallingford, CT 06492 (203) 741-0859	
<b>Title:</b> - Mounting Alternatives -	
<b>Date:</b> 12/09/09	<b>By:</b> MC
<b>Scale:</b> N/A	<b>Rev:</b> 12/09/09 by MC
<b>Page:</b> 4 OF 5	<b>Rev:</b>
<b>Alloy:</b>	<b>Rev:</b>
<b>Temper:</b>	<b>Patent:</b>
<b>Length:</b>	System - Pending
<b>Die:</b>	
<small>all contents copyright 2009 by CSW, Inc.</small>	

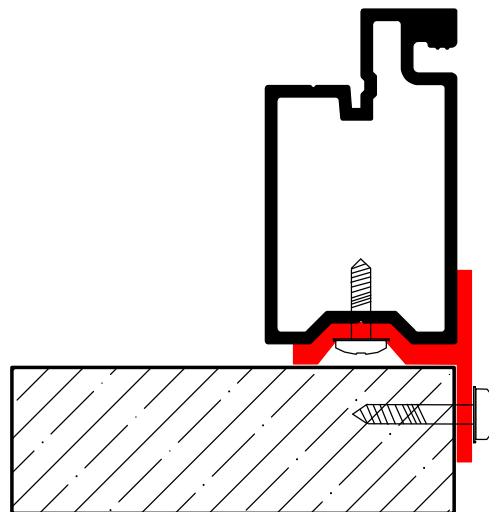
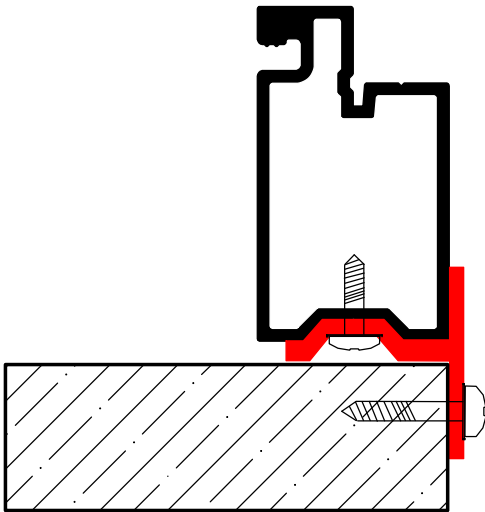

R Channel Mounts ( ALL )



	
<b>CONNECTICUT SCREEN WORKS, INC</b> Wallingford, CT 06492 (203) 741-0859	
<b>Title:</b> - Mounting Alternatives -	
<b>Date:</b> 12/09/09	<b>By:</b> MC
<b>Scale:</b> N/A	<b>Rev:</b> 12/09/09 by MC
<b>Page:</b> 5 OF 5	<b>Rev:</b>
<b>Alloy:</b>	<b>Rev:</b>
<b>Temper:</b>	<b>Patent:</b>
<b>Length:</b>	System - Pending
<b>Die:</b>	
<small>all contents copyright 2009 by CSW, Inc.</small>	