

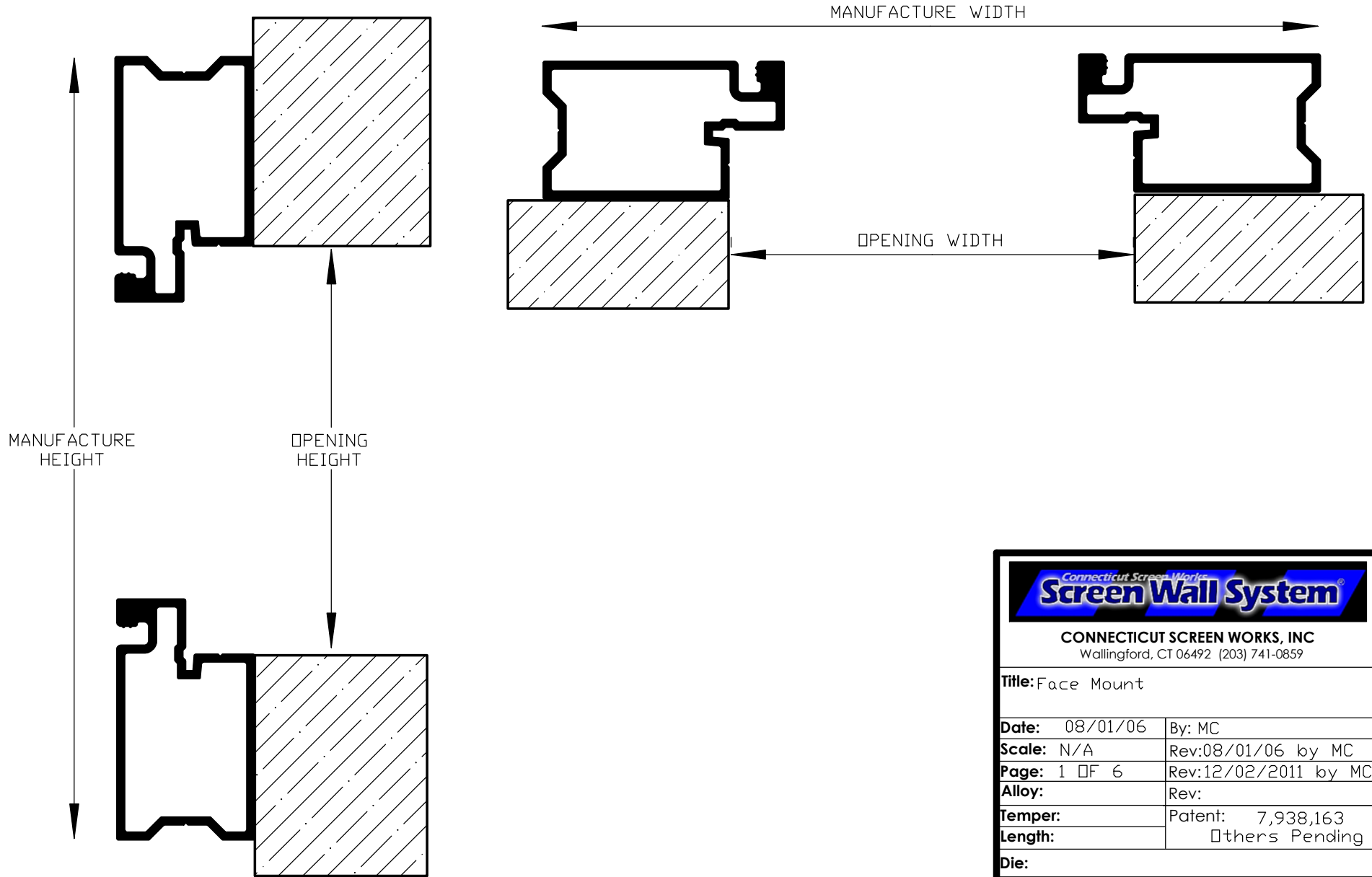

# STANDARD FACE MOUNT



	
<b>CONNECTICUT SCREEN WORKS, INC</b> Wallingford, CT 06492 (203) 741-0859	
<b>Title:</b> Face Mount	
<b>Date:</b> 08/01/06	<b>By:</b> MC
<b>Scale:</b> N/A	<b>Rev:</b> 08/01/06 by MC
<b>Page:</b> 1 OF 6	<b>Rev:</b> 12/02/2011 by MC
<b>Alloy:</b>	<b>Rev:</b>
<b>Temper:</b>	<b>Patent:</b> 7,938,163
<b>Length:</b>	Others Pending
<b>Die:</b>	
all contents copyright 2006, 2012 by CSW, Inc.	

# STANDARD FACE MOUNT

## MEASURING:

1) Measure each opening height and width. Measure in several locations (top, middle, bottom, left side, center, right side, etc.) and record the largest measurements taken. (To help, you may find it better to draw out each opening and note the measurements and locations taken)

2) Determine the amount of overlap you would like for each side of each panel.

3) Add the overlap required to the largest opening measurements taken for each opening. Remember - to include the overlap required for all 4 sides. EXAMPLE: If you require a 1" overlap on each side of your panel, you'll need to add 2" to your opening width and 2" to your opening height. This would provide a 1" overlap on all sides of your manufactured panel.

4) The resulting sizes would be your true manufacture size for each panel or wall being ordered.

You can also modify this installation as required for your particular installation requirements.

## NOTICE:

Review all information provided. There may be important information, restrictions, limitations, and recommendations concerning this mounting suggestion that can effect measurements taken and your final manufacture sizes submitted for order.

All information and directions provided herein should be treated as a generic guide which is intended to help you plan, measure and order screens. The directions herein are applicable and correct for a great majority of situations - but not all. In some situations these directions and/or your structure may need to be modified and in some, these directions should not be used. The responsibility to determine this and the responsibility to order items correctly rests solely on the customer. We make no guarantee, warrantee or promise of any kind that these directions will work in every application. Please read and understand all information provided herein and on our web sites. Web site data always supercedes printed matter

In all cases, be sure to consult and follow all local building codes.

	
<b>CONNECTICUT SCREEN WORKS, INC</b> Wallingford, CT 06492 (203) 741-0859	
<b>Title:</b> Face Mount	
<b>Date:</b> 08/01/06	<b>By:</b> MC
<b>Scale:</b> N/A	<b>Rev:</b> 08/01/06 by MC
<b>Page:</b> 2 OF 6	<b>Rev:</b> 12/02/2011 by MC
<b>Alloy:</b>	<b>Rev:</b>
<b>Temper:</b>	<b>Patent:</b> 7,938,163
<b>Length:</b>	<b>Others Pending</b>
<b>Die:</b>	
all contents copyright 2006, 2012 by CSW, Inc.	

# STANDARD FACE MOUNT

## TOP DOWN VIEW OF MASTER FRAME INSTALLED

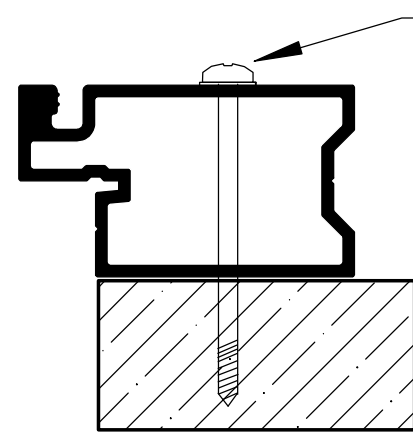
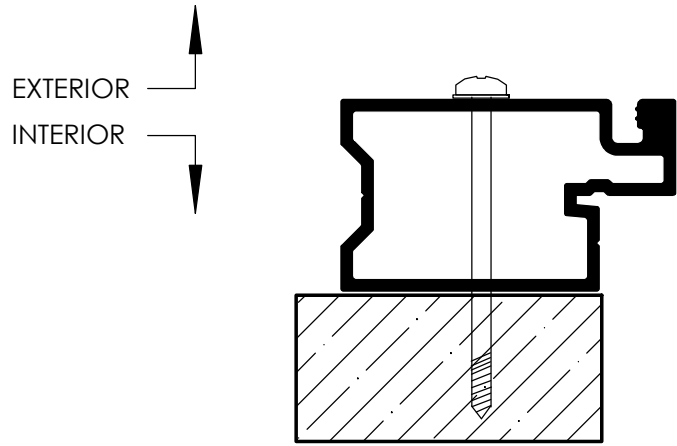

Mounting Screw:

#8 x 1-3/4" Minimum  
 #8 x 2" Preferred  
 Adjust screw type as needed based upon base material.

Screen only installations.  
 Not recommended for installation using inserts.

Standard Stainless Steel deck screw with color matched heads (counter sunk) preferred.

## VARIATIONS

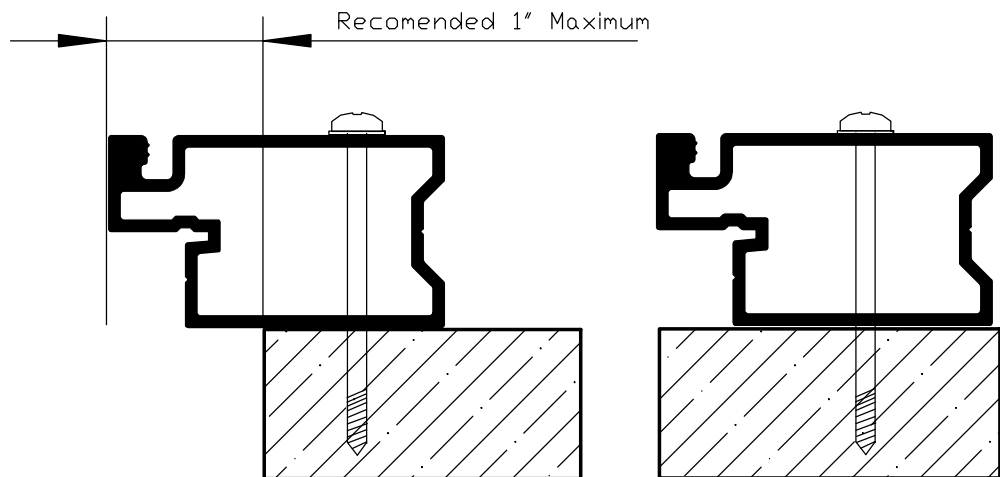

Master frame can be positioned for mounting as required.

	
<b>CONNECTICUT SCREEN WORKS, INC</b> Wallingford, CT 06492 (203) 741-0859	
<b>Title:</b> Face Mount	
<b>Date:</b> 08/01/06	<b>By:</b> MC
<b>Scale:</b> N/A	<b>Rev:</b> 08/01/06 by MC
<b>Page:</b> 3 of 6	<b>Rev:</b> 12/02/2011 by MC
<b>Alloy:</b>	<b>Rev:</b>
<b>Temper:</b>	<b>Patent:</b> 7,938,163
<b>Length:</b>	Others Pending
<b>Die:</b>	
all contents copyright 2006, 2012 by CSW, Inc.	

# STANDARD FACE MOUNT



## SIDE VIEW OF TOP MASTER FRAME INSTALLATION

Mounting Screw:

#8 x 1-3/4" Minimum  
 #8 x 2" Preferred  
 Adjust screw type as needed based upon base material.

Screen only installations.  
 Not recommended for installation using inserts.

Standard Stainless Steel deck screw with color matched heads (counter sunk) preferred.

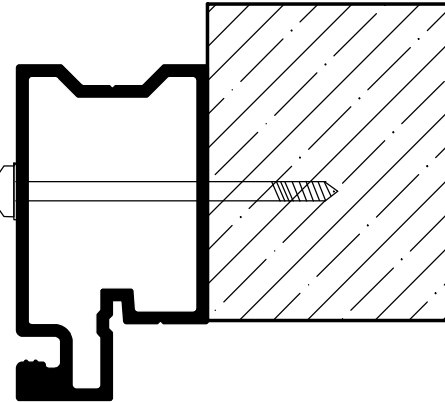

## VARIATIONS

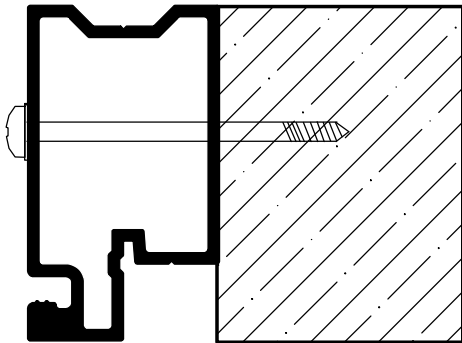

Recommended 1" Maximum

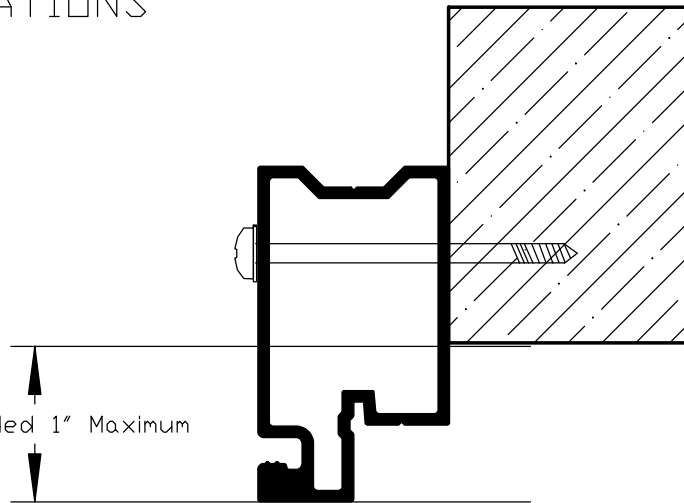

Master frame can be positioned for mounting as required.

	
<b>CONNECTICUT SCREEN WORKS, INC</b> Wallingford, CT 06492 (203) 741-0859	
<b>Title:</b> Face Mount	
<b>Date:</b> 08/01/06	<b>By:</b> MC
<b>Scale:</b> N/A	<b>Rev:</b> 08/01/06 by MC
<b>Page:</b> 4 OF 6	<b>Rev:</b> 12/02/2011 by MC
<b>Alloy:</b>	<b>Rev:</b>
<b>Temper:</b>	Patent: 7,938,163
<b>Length:</b>	Others Pending
<b>Die:</b>	
all contents copyright 2006, 2012 by CSW, Inc.	

# STANDARD FACE MOUNT



## SIDE VIEW OF LOWER MASTER FRAME INSTALLATION

Mounting Screw:

#8 x 1-3/4" Minimum  
 #8 x 2" Preferred  
 Adjust screw type as needed based upon base material.

Screen only installations.  
 Not recommended for installation using inserts.

Standard Stainless Steel deck screw with color matched heads (counter sunk) preferred.

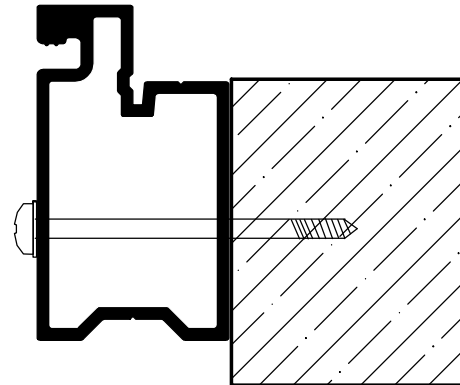

## VARIATIONS

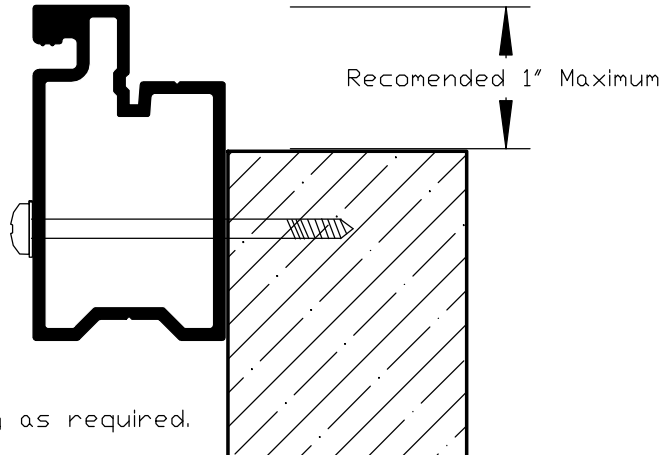
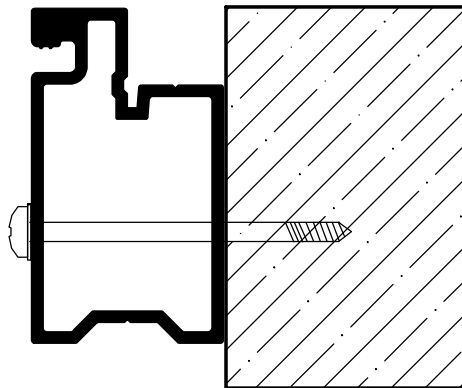

Master frame can be positioned for mounting as required.

<b>Connecticut Screen Works</b> <b>Screen Wall System</b>	
<b>CONNECTICUT SCREEN WORKS, INC</b> Wallingford, CT 06492 (203) 741-0859	
<b>Title:</b> Face Mount	
<b>Date:</b> 08/01/06	<b>By:</b> MC
<b>Scale:</b> N/A	<b>Rev:</b> 08/01/06 by MC
<b>Page:</b> 5 OF 6	<b>Rev:</b> 12/02/2011 by MC
<b>Alloy:</b>	<b>Rev:</b>
<b>Temper:</b>	<b>Patent:</b> 7,938,163
<b>Length:</b>	Others Pending
<b>Die:</b>	
<small>all contents copyright 2006, 2012 by CSW, Inc.</small>	

# STANDARD FACE MOUNT



## OPTIONAL

If installed on new pressure treated lumber use stainless steel installation screws.

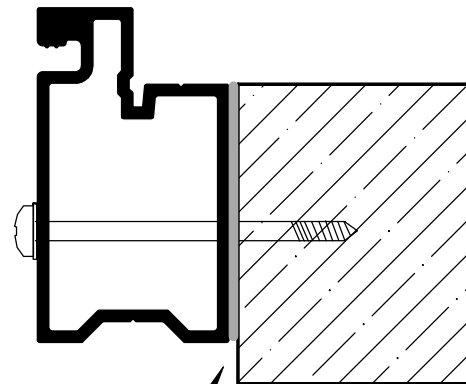

Although not required with stock finishes, a bond breaker is recommended for added protection when products are installed on metal or new pressure treated materials.

<b>CONNECTICUT SCREEN WORKS, INC</b> Wallingford, CT 06492 (203) 741-0859	
<b>Title:</b> Face Mount	
<b>Date:</b> 08/01/06	<b>By:</b> MC
<b>Scale:</b> N/A	<b>Rev:</b> 08/01/06 by MC
<b>Page:</b> 6 of 6	<b>Rev:</b> 12/02/2011 by MC
<b>Alloy:</b>	<b>Rev:</b>
<b>Temper:</b>	<b>Patent:</b> 7,938,163
<b>Length:</b>	Others Pending
<b>Die:</b>	
all contents copyright 2006, 2012 by CSW, Inc.	

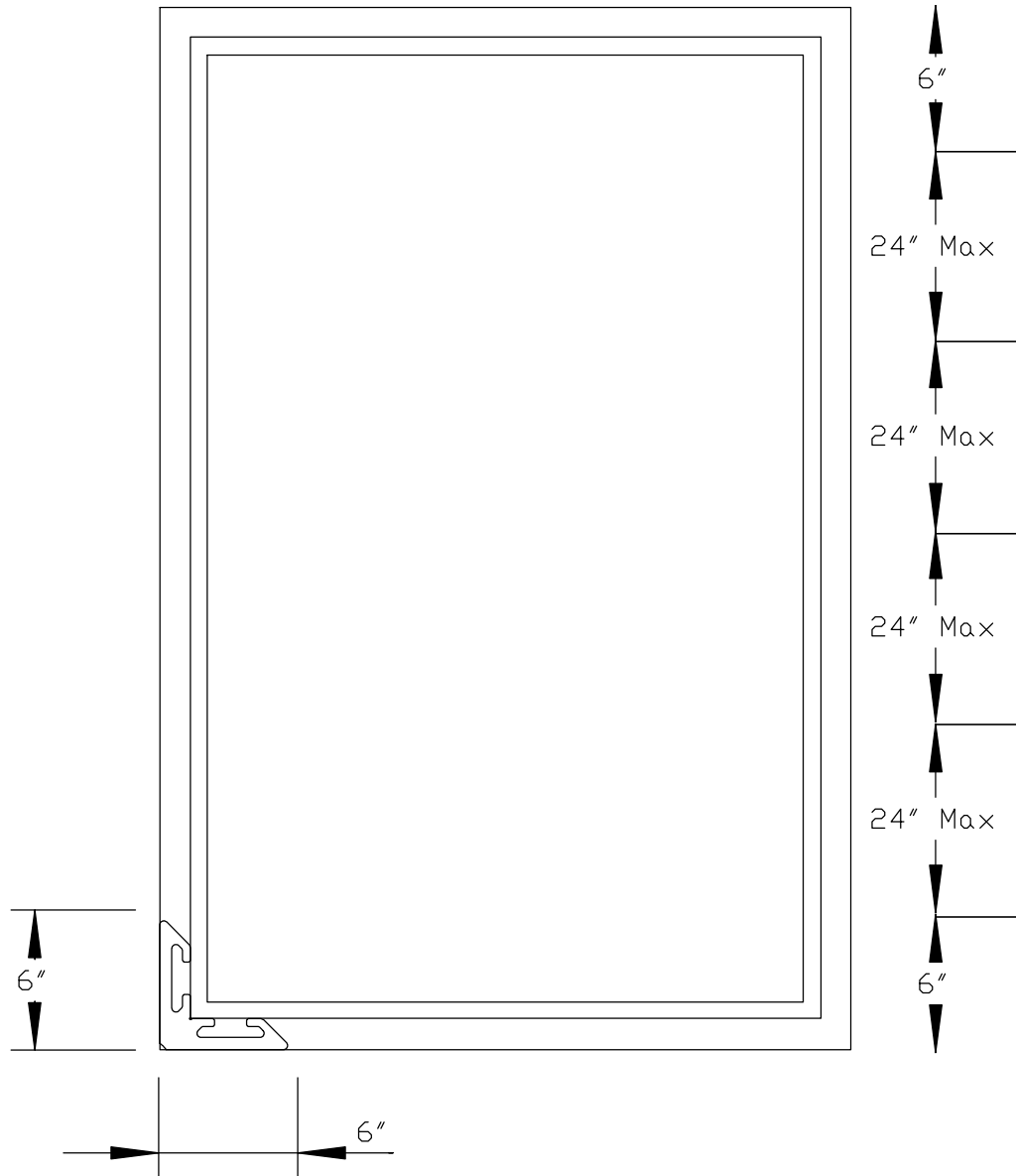

Screw pattern is the same for all mounts and installations. Stainless steel color matching trim head deck screws preferred but hardware should be adjusted as needed based upon substrate material.

- Panels and walls utilizing inserts:  
6" from outside edge then no more than 24" apart.

- Panels and walls NOT utilizing inserts:  
6" from outside edge then no more than 36" apart.

	
<b>CONNECTICUT SCREEN WORKS, INC</b> Wallingford, CT 06492 (203) 741-0895	
<b>Title:</b> Screw Patterns	
<b>Date:</b> 12/01/2011	By: MC
<b>Scale:</b> N/A	Rev:
<b>Page:</b> 1 OF 1	Rev:
<b>Alloy:</b> N/A	Rev:
<b>Temper:</b> N/A	Patent: 7,938,163
<b>Length:</b> N/A	Others Pending
<b>Die:</b>	
<small>all contents copyright 2006 by CSW, Inc.</small>	